



“people who love to eat are

always the best people” JULIA CHILD

v vegan

GFA gluten-free available

GFP gluten-free

SHAREABLES & SMALL PLATES

classic tomato bruschetta [7] new
garlic toasted crostinis . feta crema . fresh basil
roasted tomato, garlic, & red onion . balsamic reduction

buffalo brussels [6]*
flash-fried . wing sauce . bleu cheese dressing

spicy chicken nachos [11]
tostada chips . chipotle chicken . cheddar . black beans
fresh jalapeños . sour cream . roasted salsa

fresh baked pretzels [7]
beer cheese

pigs in a blanket [9]
pastry dough . smoked sausage . beer cheese

idaho nachos [8]
house potato chips . cheddar . bacon . sour cream . chives
add pulled pork or chipotle chicken [+5]

wings [12]
bleu cheese . celery . carrots
sauces: hot . xxxhot . chipotle bbq . chili lime

buffalo shrimp [10]
bleu cheese . celery . carrots
sauces: hot . xxxhot . chipotle bbq . chili lime

squashpuppies [7]
a southern delicacy . honey butter . jalapeño jam

edamame [5] GFA
sea salt . soy sauce

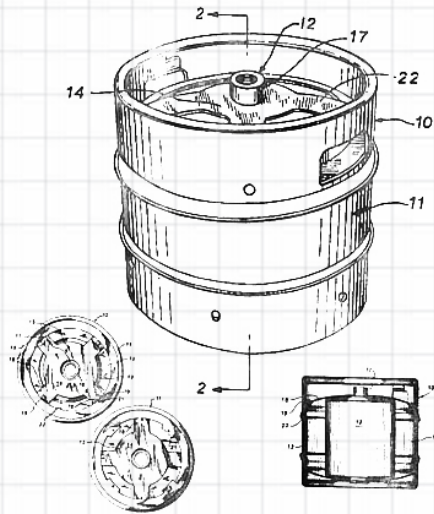

v vegan

GFA gluten-free available

GFP gluten-free

SOUP & SALADS

roasted poblano corn chowder [cup 5/bowl 6]

roasted vegetable & quinoa stew [cup 5/bowl 6] GFP
avocado . feta cheese . zucchini . corn . peas
bell pepper . tomato . salsa . cilantro

small house salad [small 5/large 8] GFA
mixed greens . egg . bacon . cherry tomatoes
pretzel croutons

wedge salad [6] GFP
butter lettuce . bleu cheese crumbles . bacon
red onion . cherry tomatoes . balsamic-glazed
black pepper . bleu cheese dressing

fresh orchard salad [6] GFA
butter lettuce . bleu cheese crumbles
sliced apple . golden raisins . spiced pecans
lemon vinaigrette . crostinis

soup & salad [10]
small house or fresh orchard salad . cup of soup

coconut-ginger shrimp salad [14]*
grilled shrimp . mixed greens . pickled carrots
spiced pecans . toasted sesame seeds . crispy rice noodles
pickled red onions . coconut-ginger vinaigrette [contains peanuts]

smoked turkey salad [12] GFA
mixed greens . smoked turkey . cheddar . bacon
egg . cherry tomatoes . tortilla strips . ranch

chili lime chicken salad [13]
mixed greens . grilled chicken breast . red onions
grape tomatoes . fresh avocado . crispy tortilla strips
parmesan cheese . creamy chili lime dressing
sub chicken tenders upon request

filet & wedge salad [4oz 18/7oz 29]* GFP
butter lettuce wedge . bleu cheese crumbles . bacon
red onion . cherry tomatoes . balsamic-glazed
black pepper . bleu cheese dressing

farm fresh chicken salad [11] GFA
butter lettuce . roasted chicken salad . sliced apple
golden raisins . spiced pecans . crostinis
lemon vinaigrette

additions

- grilled chicken [6]
- chicken tender [2]
- smoked turkey [4]
- baked salmon [10]
- grilled shrimp [6]
- fresh avocado [1]

dressings

- GFP ranch
- GFP bleu cheese
- GFP honey mustard
- GFP lemon vinaigrette
- creamy chili lime
- GFP balsamic vinaigrette
- GFP greek vinaigrette
- coconut-ginger vinaigrette [contains peanuts]

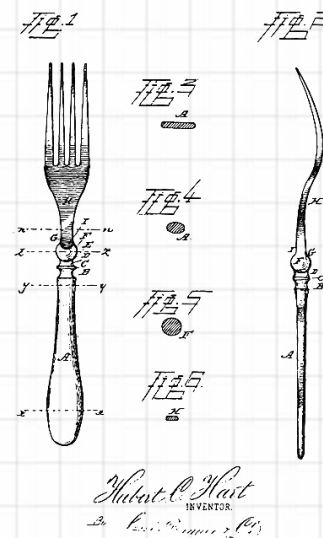

"Your body is not a temple, it's an amusement park. Enjoy the ride."

- ANTHONY BOURDAIN

At Pub W, we strive to make everything in house and from scratch.

ATTN: Individuals may be at a higher risk for a foodborne illness if the following foods are consumed raw or under cooked: eggs, beef, fish, lamb, milk products, pork, poultry & shell fish*

ATTN: Individuals may be at a higher risk for a foodborne illness if the following foods are consumed raw or under cooked: eggs, beef, fish, lamb, milk products, pork, poultry & shell fish*

 **vegan**



 **gluten-free available**

 **gluten-free**

FRESH GROUND BURGERS

served with french fries or edamame

additions & substitutions

-  garlic quinoa vegan patty
-  gluten-free bun [2]
- pretzel bun [.50]
- beer cheese [1]
- smoked bacon [1]
- fresh avocado [1]
- grilled jalapeños [1]

bacon avocado burger [12]*

bacon . smashed avocado . muenster cheese
crispy pickled onions . lettuce . tomato . chili lime sauce

pretzel burger [12]*

butter lettuce . tomato . beer cheese . fried egg
pretzel bun

killer b's [12]*

bacon . bleu cheese . balsamic-glaze . tomato
lettuce . mayo

jalapeño bacon burger [12]*

spicy aioli . cheddar . smoked bacon . grilled jalapeños

cheeseburger [11]*

mayo . pickle . lettuce . tomato . red onion
american cheese



SUB A GLUTEN-FREE BUN [+2] OR GO BUNLESS

Pub W is pleased to offer a gluten-free bun, however we are not a gluten-free restaurant. Please inform your server of any dietary restrictions.

SANDWICHES

served with french fries or edamame

additions

-  gluten-free bun [2]
- pretzel bun [.50]
- beer cheese [1]
- smoked bacon [1]
- fresh avocado [1]
- grilled jalapeños [1]

chicken & brie [13]

grilled chicken breast . fig preserves . sliced apple
field greens . melted brie . pretzel bun

smoked turkey club [11]

smoked turkey . honey mustard . butter lettuce . tomato
red onion . muenster cheese . smoked bacon . pretzel bun

chicken salad sandwich [11]

roasted chicken salad . butter lettuce . tomato . pretzel bun

chupacabra [11] (chu•puh•cah•bruh)

chipotle chicken . grilled jalapeños . grilled onions
muenster cheese . spicy aioli . jalapeño bread

avocado toast [10]

garlic jalapeño toast . smashed avocado
feta crema . sunny-side-up egg . side salad

 **vegan**

 **gluten-free available**

 **gluten-free**

LIGHT ENTREÉS

quinoa bowl [13] 395 cal

choice of grilled chicken or shrimp . rainbow quinoa
zucchini . tomato . cremini mushroom . spinach

pasta diablo [13] 442 cal

spicy sautéed shrimp . whole wheat noodles . house red sauce
shaved parmesan . basil

ENTREÉS

chicken fried filet mignon [17]

sausage gravy . mashed potatoes . green beans . jalapeño toast

fried shrimp [14] **new**

fries . squashpuppies . cocktail sauce . lemons

chipotle meatloaf [14]

mashed potatoes . green beans . jalapeño toast

moroccan salmon [18]

herb-marinated salmon . feta cream sauce . greek salad

carnitas tacos [11]

beer-braised pork shoulder . pickled red onions
feta . cilantro . rice . black beans . roasted salsa

chicken tenders [13]

hand-battered . fries . squashpuppies . honey mustard

fish & chips [14]

hand-battered . fries . squashpuppies . tartar sauce . lemons

spicy shrimp tacos [11]

flour tortillas . grilled shrimp . spicy aioli . grilled onions
grilled jalapeños . cheddar . rice . black beans

baked salmon [17]



fresh lemon . salt . pepper . evoo . edamame . rainbow quinoa

mama's chicken casserole [13]

rice . chipotle chicken . roasted poblano chowder
cheddar . sour cream . tortilla strips . green onions
black beans . add grilled jalapeños [+1]

SIDES [4]

edamame 

rainbow quinoa  

seasoned rice 

squashpuppies

balsamic-glazed brussels sprouts 

green beans 

black beans 

mashed potatoes

sweet potato fries

french fries

loaded mashed potatoes [+1.5]

DESSERTS

chocolate ganache cake [7]

house-made whipped cream
toasted coconut

butterscotch banana cake [8]

bourbon-brown sugar syrup
banana chips . house-made whipped cream
cinnamon dust

bread pudding [8]

bourbon-brown sugar syrup
house-made whipped cream

ATTN: Individuals may be at a higher risk for a foodborne illness if the following foods are consumed raw or under cooked: eggs, beef, fish, lamb, milk products, pork, poultry & shell fish*

PUBDUB®

ATTN: Individuals may be at a higher risk for a foodborne illness if the following foods are consumed raw or under cooked: eggs, beef, fish, lamb, milk products, pork, poultry & shell fish*

PUBDUB®

PICK TWO



monday - friday
11am - 2pm

SOUP

roasted poblano corn chowder

vegetable quinoa stew

SALAD

house salad

mixed greens . egg . bacon . cherry tomatoes
pretzel croutons

wedge salad

butter lettuce . bleu cheese crumbles . bacon
cherry tomatoes . red onion . balsamic reduction
black pepper . bleu cheese dressing

fresh orchard salad

butter lettuce . bleu cheese crumbles . apple slices
golden raisins . candied pecans . lemon vinaigrette
crostini

HALF SANDWICH

the chupacabra

chipotle chicken . grilled jalapeños . grilled onions
muenster . spicy aioli . grilled jalapeño bread

chicken salad

roasted chicken salad . butter lettuce . tomato
pretzel bun

smoked turkey club

smoked turkey . honey mustard . butter lettuce . tomato
red onion . muenster . smoked bacon . pretzel bun

avocado toast

garlic jalapeño toast . smashed avocado
feta crema . sunny-side-up egg

ATTN: Individuals may be at a higher risk for a foodborne illness if the following foods are consumed raw or under cooked: eggs, beef, fish, lamb, milk products, pork, poultry & shell fish*